

X:\DESIGN\AUTOCAD\PROFILE DWG\2014 PROFILES\42 CC 4' STEEL LEG PROFILE.dwg
 1/11/2015 1:49pm

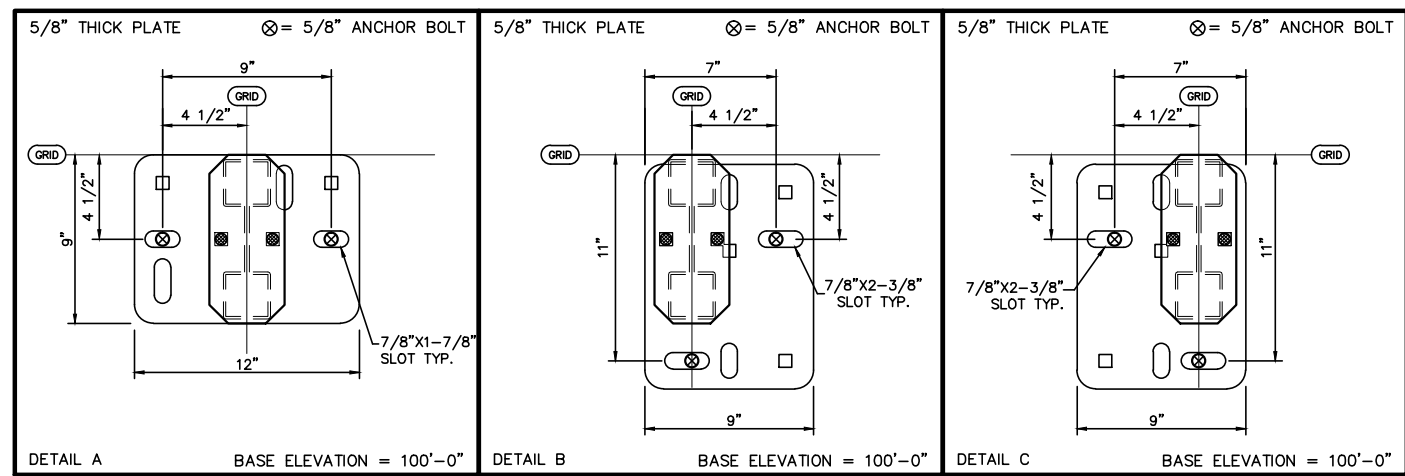
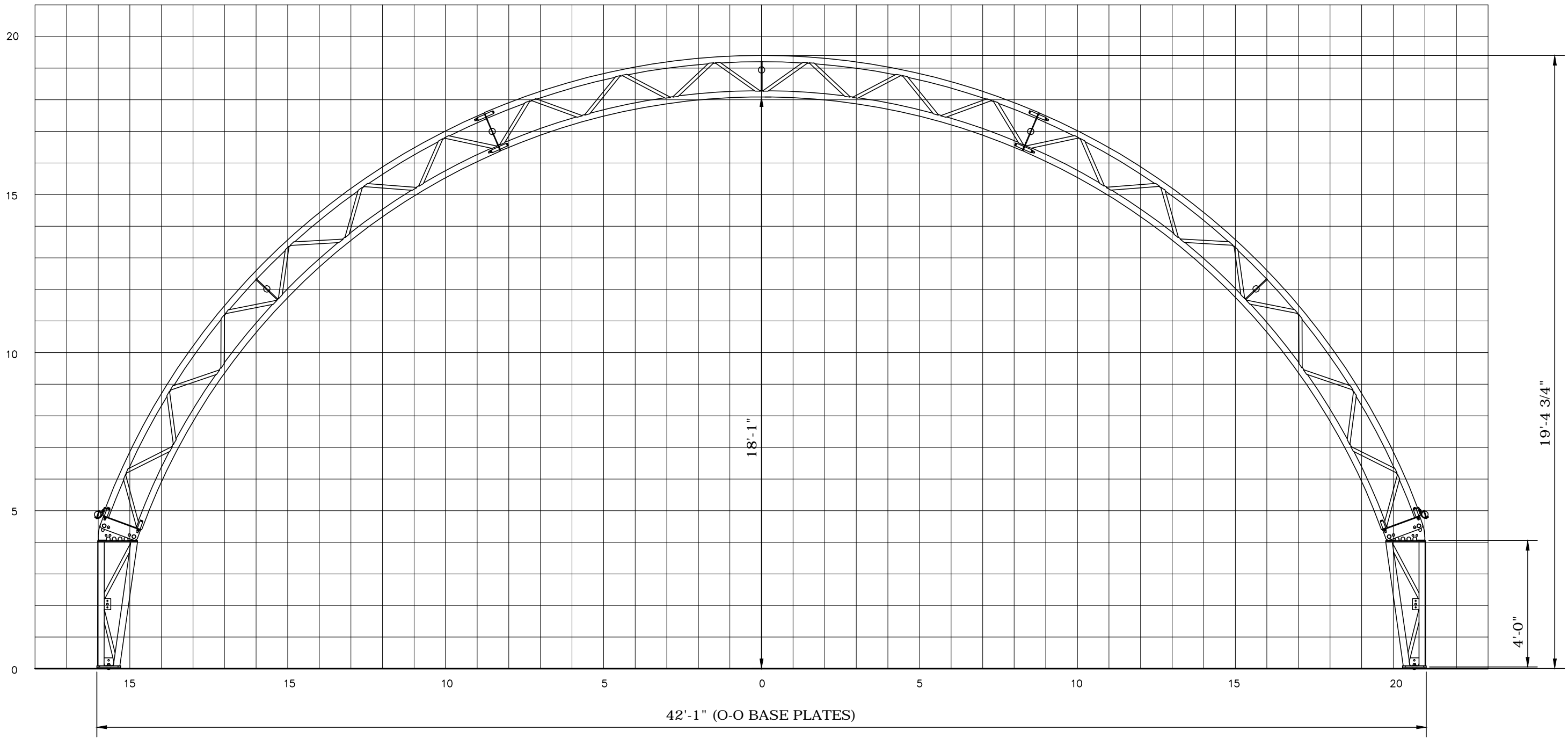

			Calhoun Superstructure Ltd. 3702 Bruce Rd #10 Tara, Ontario, Canada NOH 2N0 800-265-3994 www.calhounsuperstructure.com		
			NAME	DATE	
			DRAWN	L G G	13/06/2014
			CHECKED	R W H	13/06/2014
			ENG. APPR.		
			PROPRIETARY AND CONFIDENTIAL THE INFORMATION CONTAINED IN THIS DRAWING IS THE SOLE PROPERTY OF CALHOUN SUPERSTRUCTURE. ANY REPRODUCTION IN PART OR AS A WHOLE WITHOUT THE WRITTEN PERMISSION OF CALHOUN SUPERSTRUCTURE IS PROHIBITED		
No.	DESCRIPTION	DATE	SIZE	DWG. NO.	
			D	CC-42	
REVISION / ISSUE			SCALE:	SHEET 1 OF 1	